



RAVAS
creating intelligence



RAVAS designs and manufactures intelligent mobile weighing systems for logistics warehouses and production applications. Our innovative forklift scales, electric pallet jack scales, and hand pallet jack scales can be customized to suit your specific needs. With RAVAS, your cost centers are transformed into profit generators.

ravas.com

Table of Contents

- 01 RAVAS USA**
- 02 Why Mobile Weighing?**
- 03 Forklift Scales**
- 04 Electric Pallet Jack Scales**
- 05 Hand Pallet Jack Scales**
- 06 Data Processing & Technology**
- 07 RAVAS around the World**



RAVAS USA

RAVAS is a worldwide leader in mobile weighing systems with facilities in nine countries. Our USA headquarters and manufacturing facility are located in Twinsburg, Ohio. With a team of experienced sales and manufacturing representatives throughout the USA, RAVAS delivers customer satisfaction by providing valuable products and services.

ravas.com

WATCH THE VIDEO >

See how RAVAS is creating intelligence by scanning the QR code.



MOBILE WEIGHING SYSTEMS

A Dependable Return On Investment

When Every Second Counts

If you move 300,000 packages a day, saving just one second on each trip can add up to significant savings.

- 24 hour cycle = 300 seconds
- 300 Seconds = 83 labor hours per day

RAVAS Mobile Weighing Systems Save You Time

Save 1.5 Minutes Per Pallet = 48 minutes a day or 200 hours per year.

- With a RAVAS mobile weighing system, you can save 1.5 minutes per pallet which adds up to 48 minutes a day or 200 hours per year.
- Based on an average operator cost of \$20 per hour, you can save more than \$600,000.
- The return on investment can be achieved within 3 months.



A traditional industrial weighing process includes multiple steps and costs lift truck and pallet truck operators valuable time. With RAVAS mobile weighing solutions, operators can lift, capture the weight of a load, scan the shipment for logistics information, and wirelessly share the data — all in less than a minute.



NTEP Certified (*Legal for Trade*)

When a product is sold by weight, a RAVAS mobile weighing system with NTEP certification (*Legal for Trade*) is indispensable. Perfect for logistics and warehousing environments such as the material handling, food services, and pharmaceuticals industries.







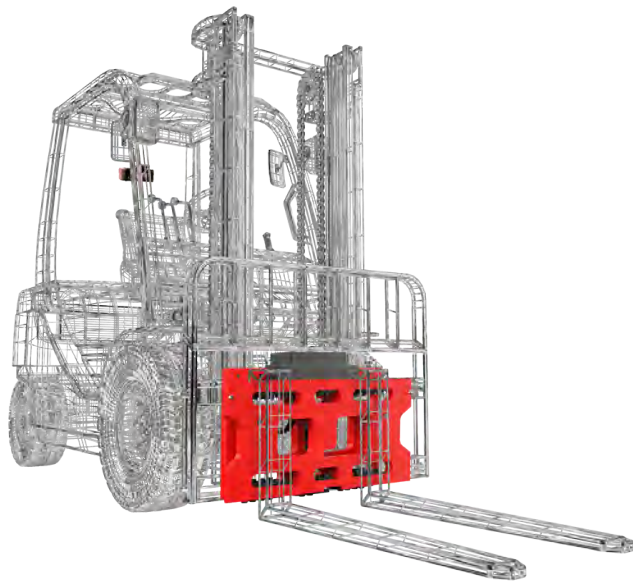

FORKLIFT SCALES

Turn your Logistical Cost Centers into Profit Generators



With the **iCP**, lifting, weighing, counting, accumulating, and transporting are accomplished as a single efficient operation. This streamlines workflows by eliminating the time-consuming task of taking shipments to remote platform scales.

Characteristics & Benefits

-  Combines with other attachments such as clamps, fork positioners, etc.
-  Attaches to Class II, III, & IV ITA carriages
-  Easy to install
-  Extremely accurate and durable
-  All indicators are resistant to water & dust
-  Wireless technology available
-  Zero modification to the forklift needed
-  Lift, weigh, count, accumulate, and transport all in one operation
-  Well suited to warehouse logistics environments

The iCP Clears Your Path to Profits

Several factors can disrupt the flow of materials in a logistics warehouse. Duplicating procedures, inaccurate shipping data, and picking delays are some of the more costly disruptions.

The iCP eliminates the roadblocks to your success.

Efficient

With the iCP, lifting, weighing, counting, accumulating, and transporting are accomplished as a single efficient operation. This streamlines workflow by eliminating the time-consuming task of taking shipments to remote platform scales.

Accurate

The iCP's unique single-load cell design provides superior load-sample linearity and maintains 0.1% accuracy from heel-to-toe and fork-to-fork. Also, the iCP is NTEP certified to ensure your legal-for-trade requirements are met.

Flexible

Compatible with most forklift truck carriages, the iCP requires no modification as it does not connect to the truck's hydraulic system. The multiple flexures absorb the shock caused when transferring the weight to the load cells.

Safety

Manufactured with two rugged grade-8 steel bolts to prevent damage to the load cells and secure the scale base for service or if the flexures fail due to unintentional abuse. The load cell rating is set to withstand an overload of 300%.



WATCH THE VIDEO >
See how the iCP can
turn cost centers into
revenue generators.



Features

FLEXURES

Manufactured with high quality spring steel, RAVAS flexures are field-replaceable, reducing maintenance expense and downtime.

CLINOMITE TECHNOLOGY

Legal for trade application, the Clinomite technology delivers weight and angle measurements to digital indicators.

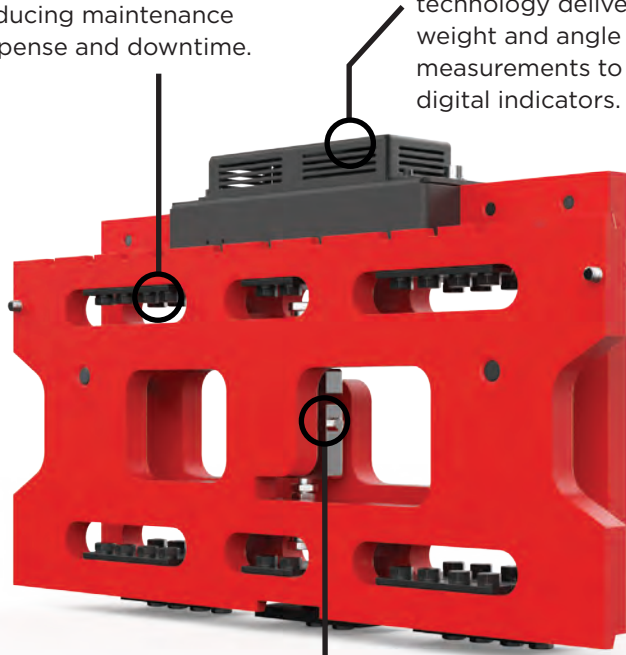

LOAD CELL

Ruggedized, field replaceable load cell provide reliable performance in challenging operating conditions.

TECHNICAL SPECIFICATIONS

	CLASS II	CLASS III	CLASS IV
Options	NTEP Certified (Legal for Trade) WiFi to ERP/WMS Cabled or Cableless	NTEP Certified (Legal for Trade) WiFi to ERP/WMS Cabled or Cableless	NTEP Certified (Legal for Trade) WiFi to ERP/WMS Cabled or Cableless
Front Plate Dimensions	16" H x 36" W	20" H x 42" W	25" H x 48" W
Back Plate Dimensions	31" W	36" W	42" W
Non-NTEP Maximum Capacity	6,000 lbs.	15,000 lbs.	10,000 lbs. 15,000 lbs. 20,000 lbs.
NTEP Capacity	5,000 lbs.	10,000 lbs.	12,000 lbs.
Graduation	5lbs at 6,000lbs capacity 10lbs at 10,000lbs capacity 20lbs at 20,000lbs capacity	5lbs at 6,000lbs capacity 10lbs at 10,000lbs capacity 20lbs at 20,000lbs capacity	5lbs at 6,000lbs capacity 10lbs at 10,000lbs capacity 20lbs at 20,000lbs capacity
System Tolerance	0.1% of load lifted	0.1% of load lifted	0.1% of load lifted

iForks

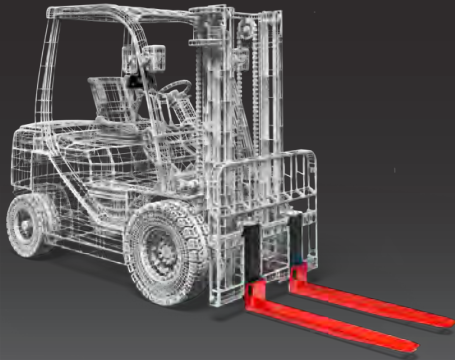

iForks-32

iForks-32 has no external components on the fork shank and is a perfect option for units with fork positioners.



iForks-52

Featuring the intuitive 520 indicator touch screen with weighing functionality and Wi-Fi connectivity.



iForks-XT

The perfect solution for low or damaged pallets.











iForks for Order Pickers

Integrated with your existing Order Picker, iForks add on-the-go weighing and capture accurate real-time data.

Increase Warehouse Productivity with Intelligent Forks



iForks are the Perfect Fit for Productivity

-  Reduce your internal logistics by 30%
-  Easy integration with your WMS/ERP business system
-  Reduce errors in your logistics process
-  Installs in 5-10 minutes and easily removed
-  Tested at 125% capacity for 1 million cycles
-  Forks are 2.6 inches high without external components needed to anchor to the forklift
-  Reinforced heel improves durability
-  Collect data in the RAVAS WeightsApp
-  Compatible with any OEM forklift brand

Customer Testimonials:

“We use RAVAS iForks for order preparation, which has meant optimizing our supply chain and avoiding picking errors. As a result, incorrect outbound orders are greatly reduced, and accurate data is made available to the WMS in real-time, quickly and efficiently.”

Kuehne + Nagel

“We installed RAVAS iForks for our electric forklifts and pallet jacks, including RAVAS indicator technology to present the weight of the pallet on a device in the form of a QR code. That way, we could import the pallet’s weight into our TWMS data set without changing our hardware or software.”

Expeditors

TECHNICAL SPECIFICATIONS



iForks-32



iForks-52



iForks-XT

Models	iForks-32	iForks-52	iForks-XT
Tolerance	0.1%	0.1%	0.1%
Graduation	0-2,000 lbs. - 2 lbs. 2,000-5,000 lbs. - 5 lbs.	0-2,000 lbs. - 2 lbs. 2,000-5,000 lbs. - 5 lbs.	0-2,000 lbs. - 2 lbs. 2,000-5,000 lbs. - 4 lbs.
Weighing Capacity	5,000 lbs.	5,000 lbs.	5,500 lbs.
Battery Life	75 Hours continuous use	75 Hours continuous use	75 Hours continuous use
Fork Length	42"	42"	48"
Fork Width	5.3"	5.3"	6.4"
Fork Height	2.6"	2.6"	1.9"
Protection Class	IP65/NEMA 4	IP65/NEMA 4	IP65
Connectivity	Wireless	Wireless Standard / 2.0 Optional WiFi	Wireless Standard / 2.0 Optional WiFi
Legal for Trade	Optional	Optional	Optional
Display	Dual color (Green/Red), Digit Height 0.78", with Backlight, 5 Digits	Full-Color 5" Touch Display with 1" High Digits Digital	Dual color (Green/Red), Digit Height 0.78", with Backlight, 5 Digits

iForks

- RAVAS WeightsApp automatic and manual zero correction
- Net and gross weighing
- Identification code (5 Digits)
- Level correction integrated with the forks
- Overload warning to Q-Max / overturning or load incorrectly positioned on the forks

Features

- Forks sized to easily slide into pallets; Standard 2.6" thickness with extra-thin 1.9" size available for iForks XT
- Installs within minutes
- Wireless connectivity for sharing with WMS
- Compatible with RAVAS WeightsApp
- Fork power supply by Li-ion compact battery packs
- 5" full color Touch screen indicator with iForks-52
- Net and gross weighing
- Counting functionality
- Integrated data connectivity as option available
- Digital calibration
- Tested 1,000,000 cycles at 125% of capacity
- Automatic compensation for mast tilt angle
- Level correction integrated with the forks



Hydraulic Scales

Mobile Weighing System for Forklifts



RCS HyQ-52



Simple installation with a T-shaped coupling; tolerance of 2%



12v powered through truck battery



Weight Capacity:
5,000 lbs. to 20,000 lbs.



IP65/NEMA 4



Graduation:

5 lbs. at 5,000 capacity
10 lbs. at 10,000 capacity
20 lbs. at 20,000 capacity



Controls:

3 Activation buttons
On/Off button

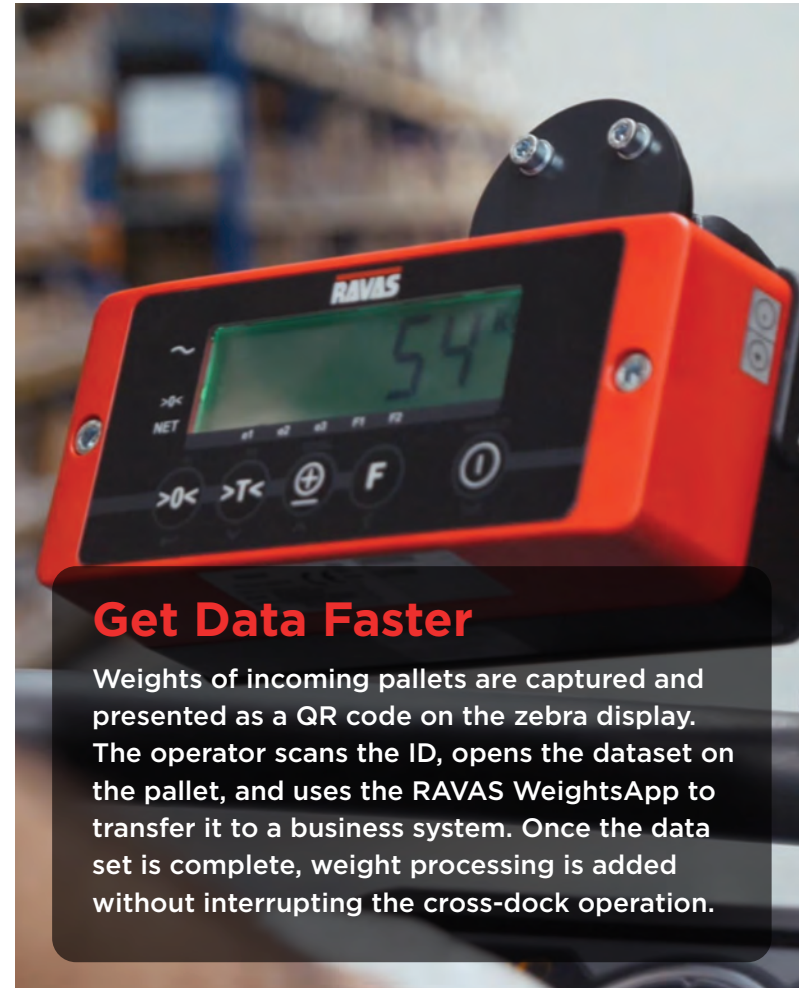

Get Data Faster

Weights of incoming pallets are captured and presented as a QR code on the zebra display. The operator scans the ID, opens the dataset on the pallet, and uses the RAVAS WeightsApp to transfer it to a business system. Once the data set is complete, weight processing is added without interrupting the cross-dock operation.



ELECTRIC PALLET JACK SCALES

When Time Equals Money, Every Second Counts



When your job is to move, weigh, and track materials as they travel through the warehouse, every second counts. Eliminating steps in your handling process can improve operational efficiencies that will add up to higher profits.

Characteristics & Benefits



Lift Up to 4,000 lbs.



Capture Weight and Share Data Wirelessly



Easy to Install



Built-in Scale & Wifi-enabled onboard indicator



Powered by Rechargeable Lithium-Ion Battery



Effortlessly Lift & Drive with Handle Controls



Ergonomic Design Improves Productivity & Safety



Easily Navigate Tight Corners



NTEP (Legal for Trade) Certified

Why Invest in the iJack?

The iJack, an electric pallet jack scale, lifts, captures an accurate weight, and stores and shares data wirelessly in real-time. By eliminating redundancies in your warehouse logistics process, iJack delivers the results you can count on.

Innovation

Outfitted with a RAVAS scale and indicator, the iJack is smarter, faster, and stronger than competitive electric pallet jacks. This next-generation electric pallet jack has a built-in scale and WiFi-enabled onboard indicator so you can stay on the move.

Capacity

Manufactured to withstand harsh warehouse environments, iJack is available in 2600 and 4000 lifting capacities. The battery-powered high-torque drive motor operates smoothly so you can navigate tight corners while keeping pace with shipping demands.

Efficiency

The iJack simplifies the time-consuming process of weighing with a floor scale. You can lift a pallet, capture the weight of the load, and share the data wirelessly in real-time with the ergonomically designed iJack. Safe and easy to operate, iJack eliminates costly delays.

Accuracy

Accurate shipping weights are essential to proper invoicing and driving revenue. RAVAS scales outperform the industry standard for accuracy. The iJack's onboard scale is NTEP (legal for trade) certified so that you can manage your legal for trade requirements with assurance.

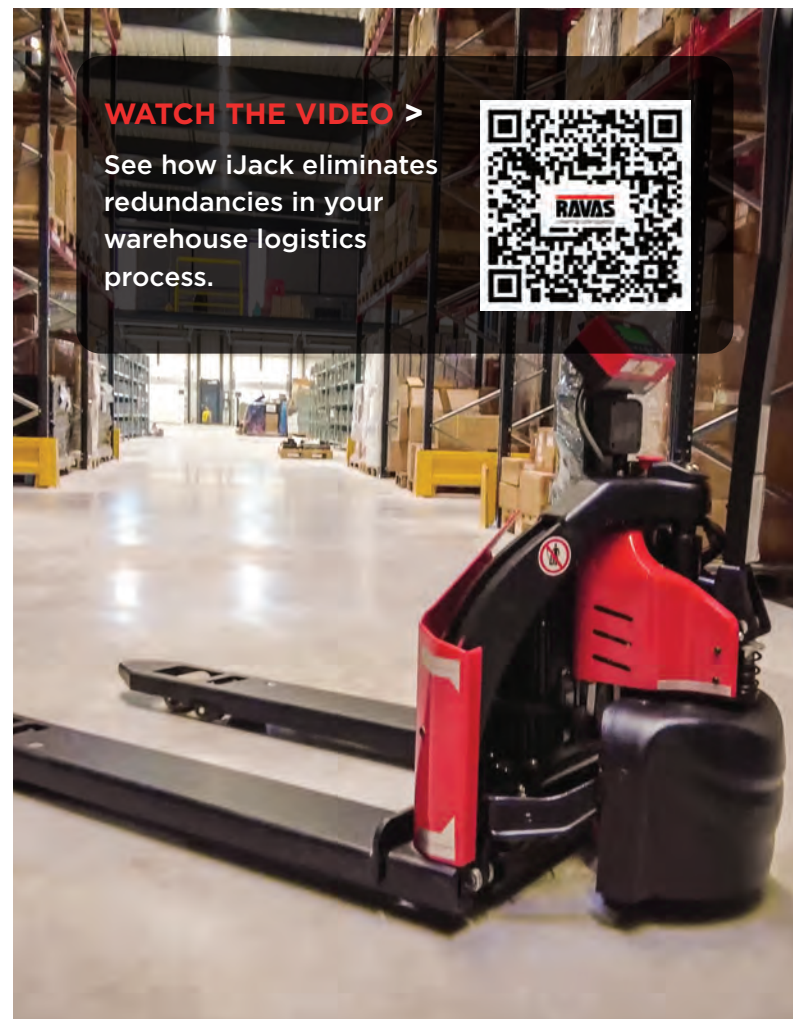

iJack



iJack-26



iJack-40



Weighing Capacity	2,600 lbs.	4,000 lbs.
Tires	Drive: 8.3" x 2.8" Polyurethane Load: 2.4" x 3.1" Polyurethane	Drive: 8.3" x 2.8" Polyurethane Load: 2.9" x 3.5" Polyurethane
Fork Dimensions	27" OAW x 45.25" OAL Standard Maximum Elevation of 7.5"	27" OAW x 46" OAL Standard Maximum Elevation of 7.75"
Hydraulics	DC Pump & Chrome Plated Cylinder	DC Pump & Chrome Plated Cylinder
Connectivity	Wireless or WiFi Connectivity / Lithium-ion battery	Wireless or WiFi Connectivity / Lithium-ion battery
Legal for Trade	Yes	Yes
Brakes	Electromagnetic Brakes	Electromagnetic Brakes

RPW EL

Optimize Your Cross Docking Operations

Mobile Weighing System for Warehouse Trucks

The RAVAS RPW EL scale is a perfect fit for all electric pallet jack brands. The fork construction of the truck is mechanically modified to mount the scale components with only 0.25 inch of added fork height. The scale indicator shows the weight on the forks, and data is transferred to WMS or ERP systems. Every load lifted is instantly weighed.

WATCH THE VIDEO >

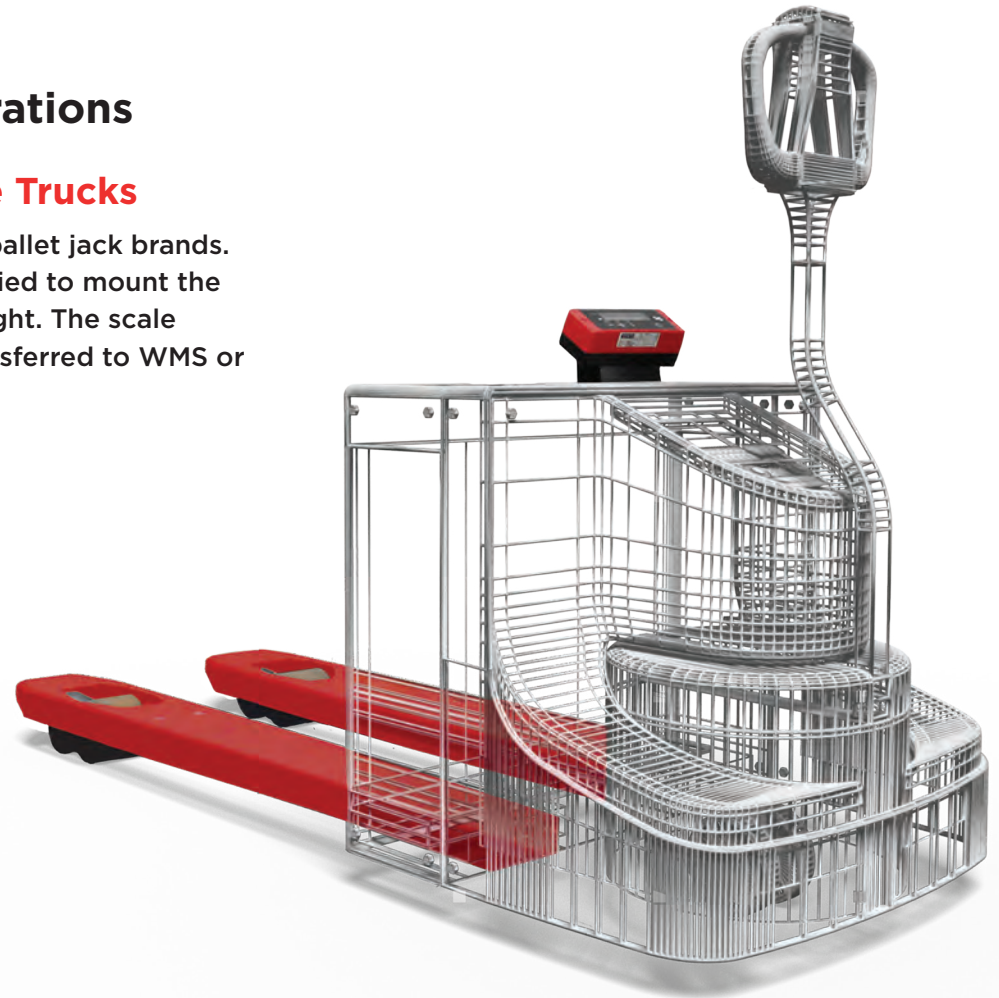

WATCH THE VIDEO >
Double Your Performance



Double Your Performance by Picking Up Two Orders at the Same Time

Double Scale

The RPW EL Double scale is designed to pick two pallets at once. Combined with a dual-scale truck, this results in 30% more efficiency because two separate orders can be picked, checked, and corrected in one movement through the warehouse.

Prevent Errors

The two-scale indicators are managed separately by your WMS or ERP. With each scale, you can check the accuracy of the weight listed on the order line. Errors are identified, corrected, and transmitted wirelessly to your WMS or ERP.

Accuracy

The dual scale order picker is accurate within 3 ounces, thanks to the RAVAS patented FlexBolts that absorb torque and longitudinal forces. This technology ensures that the load on the forks is optimally transferred to the load cell sensors and therefore measured as accurately as possible.

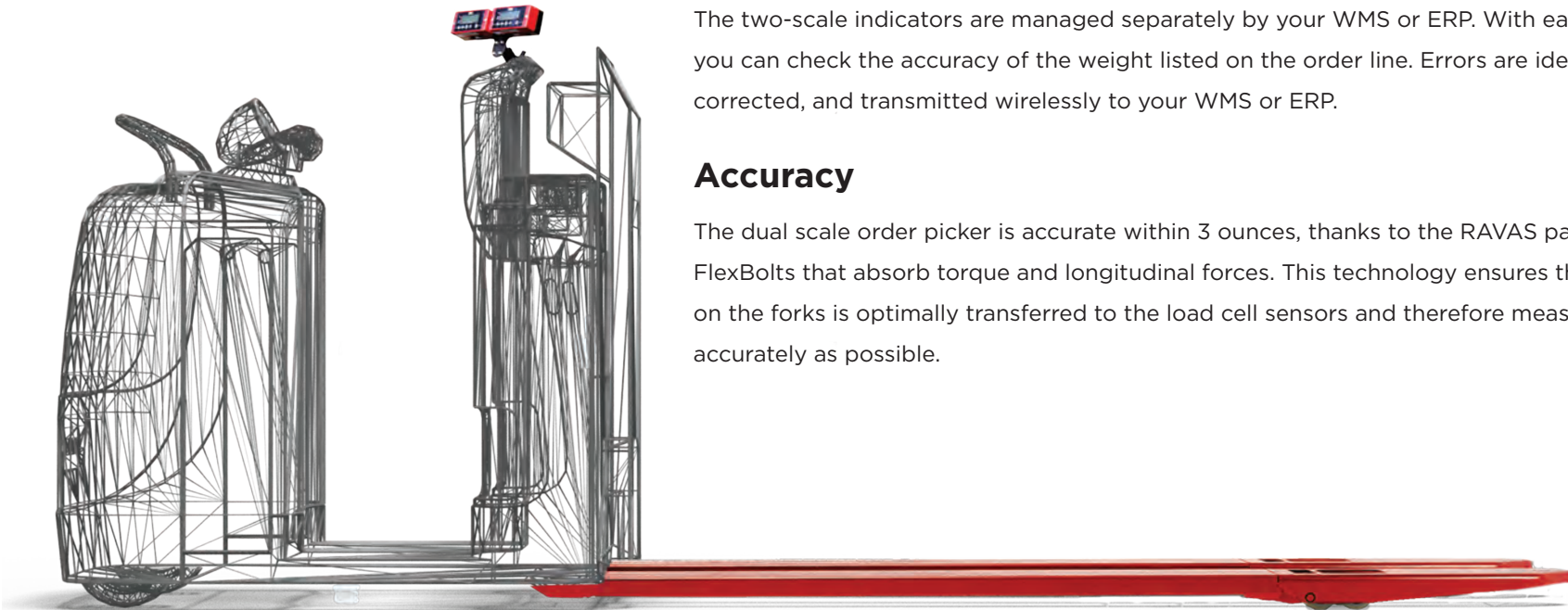



HAND PALLET JACK SCALES

Hand Pallet Jack Scales



RAVAS-110

Dependable hand pallet jack scale equipped with basic mobile weighing functionality.



RAVAS-320

Equipped with extended functionality. Standard with NTEP Legal for Trade Certification



RAVAS-520

Equipped with advanced functionality and connectivity, and powered by a Li-ion battery pack. Standard with NTEP Legal for Trade Certification



RAVAS-256X

An explosion-proof hand pallet jack scale, equipped for use in hazardous environments. Comes standard with stainless steel forks. FM certified.

TECHNICAL SPECIFICATIONS

Models	 RAVAS-110	 RAVAS-320	 RAVAS-520	 RAVAS-256X
Tolerance	0.1%	0.1%	0.1%	0.1%
Graduation	2 lbs.	0-3,000 lbs. - 1 lbs. 3,000-5,000 lbs. - 2 lbs.	0-3,000 lbs. - 1 lbs. 3,000-5,000 lbs. - 2 lbs.	1 lbs.
Weighing Capacity	5,000 lbs.	5,000 lbs.	5,000 lbs.	5,000 lbs.
Battery Life	1 Year, When used 5 times a day	75 Hours, Low Battery Indication in Display	25 Hours continuous use, 50 Hours with sleep mode	70 Hours
Steering Wheels Load Wheels	Rubber Polyurethane, Single	Rubber Polyurethane, Single	Rubber Polyurethane, Single	Rubber, Antistatic Polyurethane, Single
Protection Class	NEMA 4 / IP65	Load Cells NEMA 5, Display NEMA 4 (Printer Excluded)	Loadcells NEMA 5, Indicator NEMA 4	NEMA 4 / IP65
Connectivity	No	Wireless Standard / 2.0 Optional WiFi	Wireless Standard / 2.0 Optional WiFi	Wireless Standard / 2.0 Optional WiFi
Legal for Trade	N/A	Standard	Standard	Optional
Display	LCD, Digit Height 0.7"	LCD, Dual Color, Digit Height 0.79", Backlight	Full-Color 5" Touch Display with 1" High Digits	6 Digits, 1.2 Inch



DATA PROCESSING & TECHNOLOGY

Connectivity

How Weighing Data is Processed & Managed

RAVAS INTEGRATION SOFTWARE

Thanks to RAVAS Integration Software (RIS), mobile weighing system data management has never been easier. RIS is an easy-to-use Windows software that works with RESTful APIs that eliminates complicated programming at the ASCII character level.

With RIS, you can browse commands and establish two-way communication between RAVAS mobile weighing systems and your WMS/ERP with a WLAN network.

RAVAS DATA COLLECTOR

The RAVAS Data Collector (RDC) runs on Windows OS. It uses your warehouse's WLAN network to collect data stored on RAVAS indicators.

The RAVAS 320 and 520 indicators include the RDC protocol suite. By pressing the PRINT key on these indicators, all the weighing data is sent directly to a PC and the RDC software via an integrated WLAN module.

Indicators are also provided with a buffer to save the weighing data temporarily. This is handy when a weighing system is temporarily out of range, or there is no Wi-Fi available.

Do you have an ERP/WMS/TMS System?

No RAVAS offers you the following solutions

Do you have Wi-Fi in the warehouses?

Yes RIS RAVAS INTEGRATION SOFTWARE

No RDC RAVAS DATA COLLECTOR
RAVAS WeightsApp

Yes RAVAS systems are integrated with

Wireless WiFi RS232

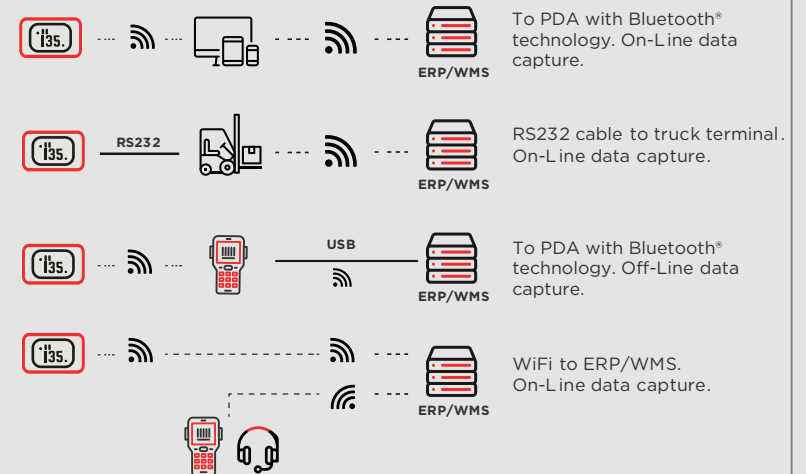

RAVAS WeightsApp

Connect with your RAVAS Weighing System



Get Data Instantly on your Smartphone

The RAVAS WeightsApp logs, tracks, and records mobile weighing data in real-time, including tare weight and identification codes for the product and the operator. Data is shared between RAVAS indicators and warehouse management systems (WMS) utilizing wireless connectivity. The data can be sent by email to a PC as a CSV file using WLAN or 3G.

The RAVAS WeightsApp works with the RAVAS 320, 520, and iCP data transmitter indicators.

Registration and login are required.



Transfer your Weighing Data into Microsoft Excel

RAVAS around the World

RAVAS is a worldwide leader in the mobile weighing systems industry. With locations in the United States, United Kingdom, France, Belgium, Germany, Netherlands, and Spain, RAVAS is dedicated to innovating and offering mobile weighing systems of the highest quality.

Headquartered in the Netherlands, RAVAS believes in changing how the material handling industry weighs products. We market our products under our brand name and allow distributors to use their own.

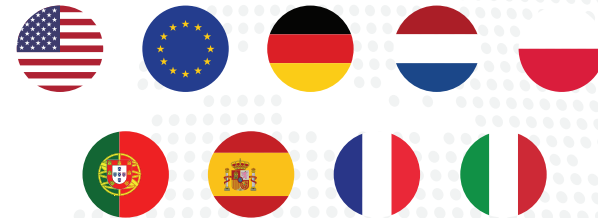

Manufacturing Plants in Europe and the USA



Over 250 Global Employees



Over 34,000 Scales Sold Annually



Global Sales & Service Network





Professionals in Sales, Service, R&D and Production





Technology and Scales Compatible with all OEM Brands

RAVAS
creating intelligence

 salesoffice-usa@ravas.com

 330.425.3092

 1500 Enterprise Pkwy, Twinsburg, OH 44087

 [RAVAS USA Weighing](#)

 [RAVAS Mobile Weighing](#)

ravas.com